

STUDY ON THE DECOMPOSITION OF KEROSENE USED AS A DIELECTRIC MEDIUM IN SPARK MACHINING

By

L. VAJTA, P. SIKLÓS and L. NAGY

Department of Chemical Technology, Polytechnical University, Budapest

(Received April 18, 1967)

A Grand Prix was awarded for the spark machining apparatus *Erosimat* to its Hungarian producers at the World Exhibition 1958 in Brussels. These machines are still manufactured by the Hungarian industry, at present by Csepel Vas- és Fémművek Híradástechnikai Gépgyára (Telecommunication Machinery Branch of the Csepel Iron and Metal Works Co.). In the course of the development of a new type some problems were encountered for the solution of which the co-operation of the Department of Chemical Technology of the Technical University, Budapest, was sought.

The fundamental principles underlying the operation of a spark machining apparatus are given in phenomena perceived long ago [1]. It has been observed that when an electric arc is produced between metal electrodes dipped below the surface of a dielectric liquid, then minute particles of the metal become detached to it. This process was already utilized at the beginning of this century by BREDIG, for the preparation of colloid suspensions of metals. About 20 years later, Kohlschütter developed this method further in so far as he applied a condenser in parallel to the gap between the electrodes. Then oscillating spark discharges occurred and the weight loss of the positive electrode increased significantly as compared with that of the cathode.

The observation of mass transfer phenomena that accompany electric discharges in air formed another source of ideas leading to electric cutting techniques. The destruction, the so-called electric erosion of the contact terminals of electric switches is also known since long. The fundamental idea in spark machining is that electric erosion, the effect of which was found to be damaging, should be turned to advantage and utilized for the localized destruction of metallic bodies by directed electric discharges. The elaboration of this method, and the solution of its industrial application are the results of the researches carried out by the Soviet scientists Mr and Mrs LASARENKO who are thus regarded as the inventors of this technique. The principle of this method is shown by the schematic circuit in *Fig. 1*.

Condenser C is charged through impedance R from the electric source. When a certain potential has been built up a discharge occurs in the form

of a spark between the two electrodes. This process is then quickly repeated. The gap between the two electrodes is kept approximately constant with the aid of an automatic mechanism marked "Control" on the schematic diagram in *Fig. 1*. During operation the electrodes cannot come into contact, and the coalescence of the sparks into a continuous arc is also prevented.

Discharge always occurs at the points of greatest field strength, i.e. at the points being nearest to each other on the electrodes. Discharges explode small particles on both surfaces, in consequence of this the shape of one electrode will be copied on to the other. Through a suitable electric circuit it

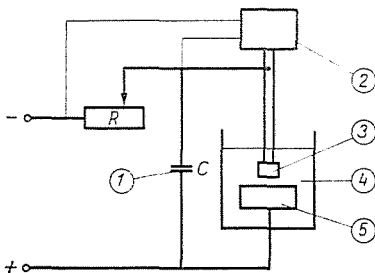

Fig. 1. Schematic diagram of a spark machining circuit.
(1) Condenser; (2) Control; (3) Tool electrode; (4) Dielectric medium; (5) Work piece

can be arranged that from the electrode used as the tool, less substance will be exploded by the sparks than from the piece to be worked and, in consequence, that in the worked piece a cavity or a hole, practically the exact negative of the tool electrode will be formed. By the variation of the capacity of the condenser it is possible to adjust the discharges to be of greater or lesser energy. Accordingly, chipping can be used for rough or fine machining of a metal surface.

It has been mentioned that a primary condition for the industrial application of spark machining is the filling in of the gap between the electrodes with a dielectric liquid. In Hungary, kerosene is mainly used for this purpose. This is advantageous because the breakdown resistance of petroleum is nearly as high as that of transformer oils and its viscosity is considerably lower, therefore it can be applied at greater advantage than transformer oil in fine machining, when the gap between the electrodes is comparatively small. During operation, metal particles get into the kerosene from the anode and the cathode, further, due to the decomposition of the kerosene, finely dispersed carbon, similar to carbon black, is formed as well. In a spark machining apparatus the dielectric liquid is circulated by a pump and solid particles suspended in the liquid are removed, continuously or intermittently. This removal can be carried out by filtration, separation, or more simply, by settling.

It is obvious that part of the kerosene will be decomposed during spark machining operation. It is surprising that no publication that deals with the chemical changes brought about during spark machining is to be found in the literature. This can be explained perhaps by the fact that questions of spark machining were studied up till now by electrical and mechanical engineers, and by physicists. — Only the co-workers of LASARENKO, namely PETCHURO, MERKURYEV, GRODZINSKY and SOKOLOVA [2] report briefly on the decomposition of the dielectric, and on the decomposition products. Apart from this paper only such are to be found, which deal with the questions of so-called electro-cracking. The process of electro-cracking, though similar to spark machining, is characterized by features quite different from those of the latter.

In studies of electro-cracking, various authors generated arc discharges below the surface of hydrocarbons and investigated mainly the acetylene content of the gases formed in the process.

In electro-cracking experiments, CONTARDI used benzene, toluene, naphthalene, and pseudo-cumene as the dielectric. The acetylene content of the gas mixture was between 18 and 34 per cent by volume; its hydrogen content was between 51 and 69 vol. per cent.

The French firm *Air Liquide* decomposed heavy petroleum fractions with electric discharges in order to produce acetylene. According to their data, besides 1 st. cu. m. of acetylene, 0.5 kg of carbon black, and 0.5 st. cu. m. of other gases were formed.

Experiments of DOBRYANSKY and KOKURIN have shown that the character of the starting material does not influence to any significant degree the acetylene concentration of the gas mixture produced. In the crack-gases of kerosene, goudron, shale-tar, peat-tar, and diesel oil made from shale-tar, acetylene content varied between 32.2 and 35.5 vol. per cent. TATARINOV carried out decomposition experiments within the voltages ranging from 120 to 1000 Volts. The average composition of the gas mixture thus obtained was found to be the following

H ₂	40.0	per cent by volume
CH ₄	15.0	"
C ₂ H ₂	30.0	"
C ₂ H ₄	10.0	"
C _n H _{2n}	4.0	"
CO + CO ₂ + O ₂	1.0	"

FESTER, MARTINUZZI and RICCARDI tried to establish a connection between the electrode substance and the acetylene content of the gas mixture generated by discharge. They found that using electrodes having lower boiling

points, the acetylene content of the gas mixture generally increased. PETCHURO, MERKURYEV, GRODZINSKY and SOKOLOVA [2] carried out their laboratory experiments in a specially adopted spark machining apparatus, with various petroleum and shale-oil products. They investigated every gaseous and solid product of the chemical decomposition, as well as the dielectric medium that had changed its technical properties.

In these experiments the condenser capacity varied between 12.5 and 500 microfarads, the current intensity between 1 and 5 Amperes, the voltage

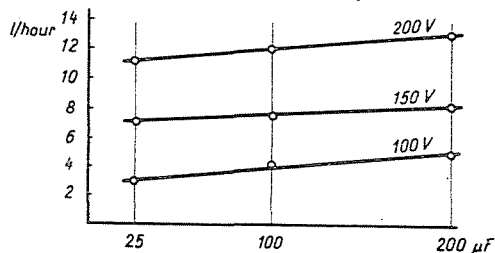

Fig. 2. Variation of the rate of gas evolution from kerosene used as the dielectric medium

between 100 and 200 Volts. The rate of evolution and the composition of the gas were determined as functions of condenser capacity at constant voltage. Their results are shown in Figs 2,3 and 4. From these graphs it is to be

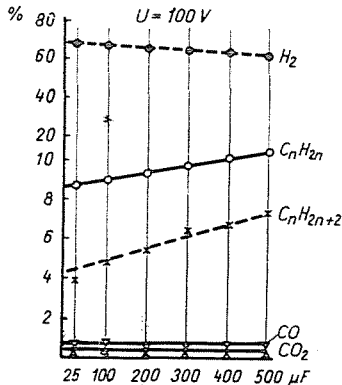

Fig. 3. Composition of the gas evolved from kerosene

seen that an increase of condenser capacity at constant voltage, or an increase of voltage at constant capacity, i.e. the increase of the energy of the discharges, increases the generation of gas. As to the composition of the gas, it was found that increase of capacity increases the evolution of saturated and unsaturated hydrocarbons, and that hydrogen content decreases somewhat. According to their records, evolution and composition of gas is a function of the shape of the electrode as well.

Unfortunately, in the study referred to, contrary to those dealing with electro-cracking, no reference is to be found to the acetylene content of the gases formed, only the total of the unsaturated hydrocarbons is given. Though it is understandable that the composition of gases formed during spark machining differs from that of gases evolved in electro-cracking, the extent of changes in the composition of the gas mixture caused by a change of the dielectric is remarkable (cf. *Figs 3 and 4*). It is also surprising that in the

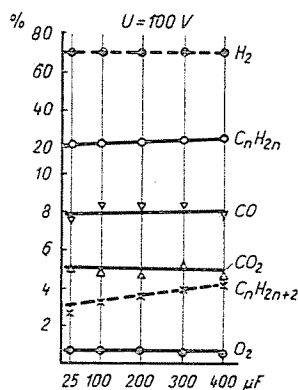

Fig. 4. Composition of the gas evolved from shale oil

gas, resulting from the decomposition of the petroleum fraction comparatively small amount of unsaturated compounds (C_nH_{2n}) was found.

After spark machining, the density of the petroleum products used as dielectric media increased slightly, their flash and ignition temperatures became higher, their viscosity and refractive index increased too. Also initial and final boiling points were higher.

The solid products of spark machining were separated by settling and decantation, and used as fillers or plasticizers, in rubber. Detailed data show how this additive improves the properties of vulcanisates. No experiments for a more thorough investigation of these solid residues were carried out.

In the paper quoted [2] answers are lacking to several questions, therefore, in order to acquire a better understanding of the qualitative and quantitative aspects of the processes that occur in the dielectric, spark machining experiments were carried out in our laboratory. For this purpose an *Erosimat* Type C apparatus of the Csepel Iron and Metal Works Co. was modified.

Experimental apparatus

The co-ordinate table and work pan of the machine were removed and an enamelled vessel of about 7 litre capacity was put in their place. Thus

instead of in 70 litres of oil originally kept in circulation, spark machining could be carried out in 6 litres of kerosene.

A photograph of the modified apparatus is shown in *Fig. 5*, the schematic arrangement of the work pan is to be seen in *Fig. 6*. Over the cylindrical copper electrode (2) of 20 mm diameter a glass bell (5) was fastened by an

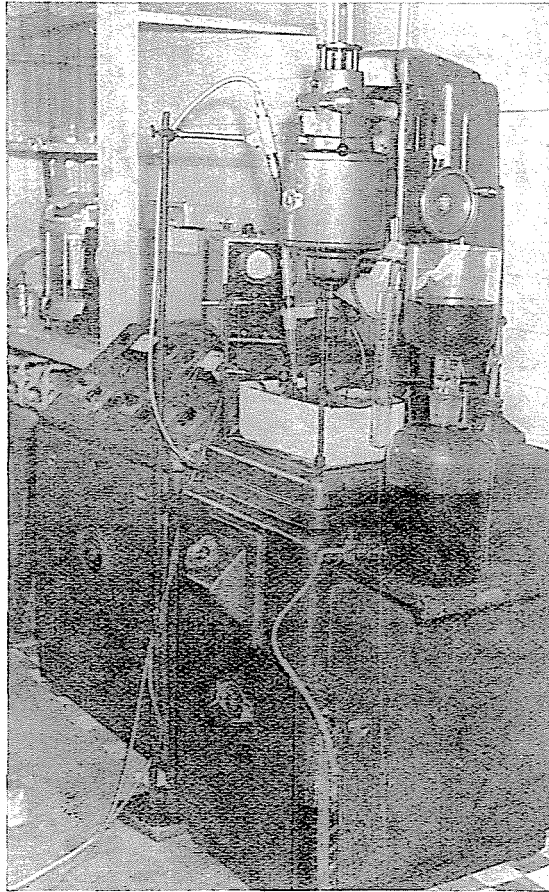

Fig. 5. Photograph of the modified apparatus

airtight seal so that gases evolved could be collected continuously. This glass bell was connected to a manometer (6) and a gasholder (7). The work piece was made of Cr S-1 tool steel, or carbon steel (4). By means of a cooling system (11) and stirrer (9) the dielectric fluid could be kept at constant and uniform temperature during operation.

As a dielectric medium, commercially available kerosene was used throughout.

With the apparatus described, rough and fine machining, each in 4 grades, could be performed.

Changes in the properties of the kerosene

Tables 1 and 2 list the characteristics of the kerosene before use, and after 8 hours of rough and 40 hours of fine machining.

Data in the Tables show that density, viscosity, flash point, and ignition point of the kerosene increased, its refractive index became higher, and the

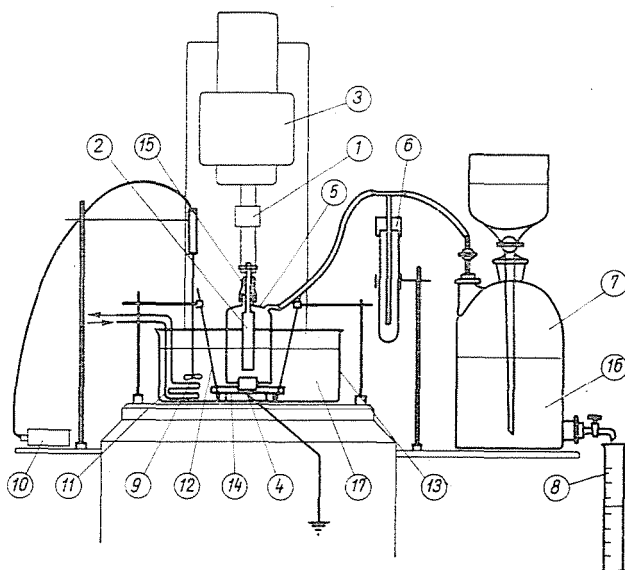

Fig. 6. Schematic drawing of the arrangement of the work plate.

(1) Spindle; (2) Tool electrode; (3) Control mechanism; (4) Work piece; (5) Glass bell for gas recovery; (6) Manostat; (7) Gas container; (8) Calibrated cylinder; (9) Stirrer; (10) Stirrer motor; (11) Cooling coil; (12) Fixing rods; (13) Enamelled vessel; (14) Perspex plate; (15) Robber seal; (16) Sealing fluid; (17) Dielectric medium (kerosene)

Table 1

	Unused kerosene	Kerosene used for 48 hours
Density at 20 °C, g/ml	0.8197	0.8232
Flash point, closed vessel, acc. to PENSKY—MARTENS, °C	46	74
Flash point, open cup, acc. to MARCUSSEN, °C	65	86
Ignition temp., °C, acc. to MARCUSSEN	73	98
Viscosity at 20 °C, cSt	2.06	2.36
Refractive index, n_D^{20}	1.4571	1.4608

Table 2

	Unused kerosene	Kerosene used for 48 hours	Kerosene after storage of the work-pan for 168 hours
Initial boiling point, °C	165	198	183
5 vol.% distilled, °C	182	207	193
10 vol.% .. °C	188	211	197
30 vol.% .. °C	205	218	208
50 vol.% .. °C	216	227	219
70 vol.% .. °C	228	237	231
90 vol.% .. °C	247	254	248
95 vol.% .. °C	257	263	259
Final boiling point, °C	270	274	268
Total distilled, vol.%	97.5	97.5	97.5
Residue, vol.%	1.8	1.6	1.6
Loss, vol.%	0.7	0.9	0.9
Average b.p., °C	216.8	229.2	220.6
Average molecular weight	165	182	170

results of the distillation test shifted towards higher boiling points; thus, we found a change in the kerosene similar to that noted by PETCHURO et al.

If the cause of this change is sought in the effects of the electric discharges, then the unlikely conclusion offers itself that due to the effect of the sparks, hydrocarbons of lower molecular weights are decomposed more rapidly than are those of higher molecular weights, whereas it is well known that high molecular weight hydrocarbons are the more easily decomposed. Only part of the changes might be accounted for by assuming that condensation products of high molecular weight are formed during the process, since the rise of flash point and the changes in the first section of the distillation curve seem to indicate that the amount of low molecular weight hydrocarbons decreased considerably. To check the results just mentioned, unused kerosene was poured into the enamelled vessel of the modified apparatus and some characteristics of this kerosene were determined after 168 hours' storage. These characteristics are listed in Table 2, and show that during storage changes similar to those found after spark machining were produced. "Kerosene used for 48 hours" in Tables 1 and 2, was left for about one week, i.e. 168 hours in the vessel and the spark machining test was carried out within this week. It must be taken into consideration that during operation of the apparatus the temperature of kerosene rises by about 20 °C and gases are leaving the liquid. These two phenomena accelerate the evaporation of components of lower boiling points. Accordingly, some of the changes that

occur in the characteristics of the kerosene might be ascribed to the evaporation of the light fractions and less importance is to be attributed to the effects of the electric discharges.

In the opinion of the authors the effect of the electric discharges is more important inasmuch as the chemical changes of the kerosene are considered. Also PETCHURO et al. have noted that after use in spark machining, the part of the kerosene that can be sulphonated according to KATTWINKEL, increases by about 1 to 2 per cent. The group composition of the kerosene was determined before and after use, according to the FIA method. The results are listed in *Table 3*.

Table 3

	Unused kerosene	Kerosene used for 48 hours
Aromatic hydrocarbons vol.%	17.7	10.5
Olefinic hydrocarbons vol.%	—	4.4
Saturated hydrocarbons vol.%	82.3	71.5

Evaporation of the light components of kerosene may bring about a change in group composition since, as is known, the fractions having higher boiling points have, generally, a more pronounced aromatic character. However, the changes shown in *Table 3* are too great to be explained on the basis of evaporation alone. Thus, the statement that under the influence of electric discharges paraffins decompose more rapidly than do aromatic compounds, seems to be justified. It is also possible that, due to secondary reactions that accompany decomposition, aromatic hydrocarbons are formed. Possibly, such reactions are the dehydrogenation of the naphthene ring, and the condensation of unsaturated compounds. The formation of liquid olefinic compounds cannot be explained but as an effect of the discharges.

Surely, the effect of electric discharges upon the conversion of kerosene is a complex process. Decomposition of the hydrocarbons is not due solely to ionization, radiation, and direct thermal effects, cracking will be caused also by the very hot surfaces of the detached metal particles; most probably the catalytic action of the metal will also play a role.

Solid and gaseous products

From the practical point of view it is useful to know how much gas and coke are produced by the chipping off of a unit quantity of metal. These data are referred to as specific gas evolution and specific carbon formation, respectively. The knowledge of these might be important e.g. for the design of an apparatus and for the calculation of the dimensions of the system for the

purification of the dielectric liquid. Since no data on this subject were found in the literature, some sets of experiments were carried out by the authors. The results are discussed briefly in the following.

Machining, notably in three rough, and four fine grades was carried out. Carbon steel was machined with a cylindric copper electrode of 20 mm diameter; the voltage at the spark gap was kept at a nearly constant value. After each of the several runs the weight loss of the electrodes was determined

Table 4
Quantity of products at various grades of machining

Grade of machining		Electrode loss, g/hour	Test piece loss, g/hour	Total metal loss, g/hour	Gas evolved, st. l./hour	Carbon formed, g/hour	Specific	
Mark	Capacity, μ F						gas evolution, st. l./g	carbon formation, g/g
S-1	0.003	0.015	0.024	0.039	0.162			
S-2	0.053	0.126	0.426	0.552	1.56			
S-3	0.153	0.282	0.900	1.18	3.18			
S-4	0.50	0.59	1.48	2.07	4.47	1.34	3.02	0.908
N-1	10	3.25	10.27	13.52	12.8	3.67	1.24	0.357
N-2	18	7.84	21.48	29.32	17.4	5.48	0.810	0.254
N-3	30	10.13	25.78	35.87	21.9	5.11	0.851	0.198

and the volume of the gas evolved was measured. The solid residue was separated from the kerosene, this residue contained, besides metal particles, a substance, similar to carbon black, from the decomposition of the kerosene. Such determinations were not carried out for finest polishing. The solids, recovered by settling and centrifuging, were washed in gasoline, and weighed; their carbon and hydrogen content was determined as carbon dioxide and water, respectively, after combustion in oxygen stream in a Dennstedt apparatus. The residue of the combustion was taken up in hydrochloric acid and in nitric acid, then its iron and copper content was determined. A material balance was then set up. From the weight and composition of the solid residue the quantities of copper and steel expended were calculated. The values thus obtained were in good agreement with the losses of weight of the work piece and the tool electrode, respectively. Numerical values are listed in *Table 4*. S-1 marks the finest grade of machining, S-4 the roughest grade; similar N-markings indicate rough machinings.

In *Fig. 7* the changes of

gas evolution rate	Curve 1
quantity detached, carbon steel, g/hour	Curve 2
weight loss of copper electrode, g/hour	Curve 3
rate of carbon formation, g/hour	Curve 4

are plotted as functions of condenser capacities used in the different grades of machining.

Fig. 8 shows the correlation of specific gas evolution and carbon formation, referred to unit weight loss of the machined piece.

Results in Table 4 and Fig. 7 show that the rate of gas evolution and carbon formation increases of course when rough machining with sparks of higher energy is carried out. On the other hand, specific values (cf. Fig. 8) fall rapidly when the condenser capacity is increased.

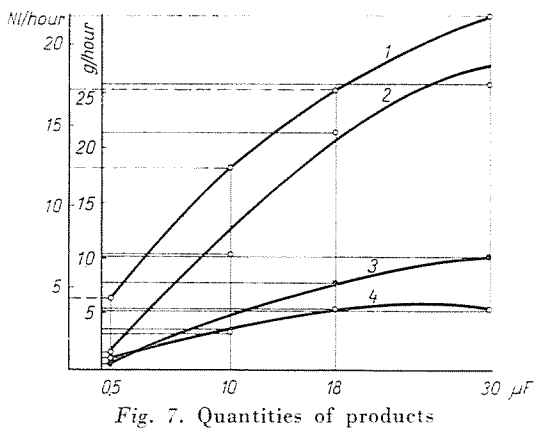

Fig. 7. Quantities of products

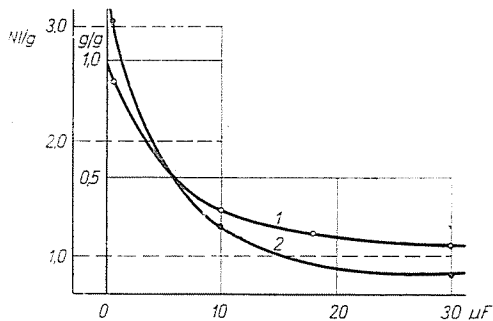

Fig. 8. Specific values as functions of condenser capacity. (1) Specific carbon formation, g/g; (2) Specific gas evolution, st./g

Obviously, the amount of the gas and carbon formed, as well as the mass of metal exploded by a single spark discharge are the functions of the energy set free at discharge. The findings just mentioned might be explained on the basis that when the energy of the spark increases the increment of the decomposed mass of the dielectric medium is not as high as the increment of the exploded mass of metal. In other words, when energy consumption at the spark gap increases, proportionally less energy is consumed by chemical decomposition, i.e. pyrolysis of the kerosene, thus a better utilization of energy by the spark machining process will occur.

Study of the gas evolved

The composition of the gas evolved during spark machining and collected in the gas container was determined by gas chromatography. The results are listed in *Table 5*.

Table 5

Composition of gas samples

H ₂	from 65.0 to 69.0	vol. per cent			
CH ₄	.. 5.8 .. 7.8
C ₂ H ₂	.. 17.4 .. 21.2
C ₂ H ₄	.. 5.2 .. 7.5
C ₂ H ₆	.. 0.2 .. 0.3
C ₃ H ₆	.. 0.2 .. 0.3
C ₃ H ₈	not more than 0.01 vol. per cent				

The acetylene content is highest, of course, since at the high temperature of the spark gap acetylene is thermodynamically the most stable hydrocarbon. The total of the unsaturated gases was between 22.8 and 28.0 vol. per cent.

In the course of the studies concerning the rate of gas evolution, and the composition of the gas evolved, some phenomena were noted that, besides their relevance to the chemical decomposition of the dielectric liquid, are of interest from the point of view of design and operation of the spark machining apparatus. These phenomena will be discussed in a subsequent paper.

We wish to acknowledge our indebtedness to Readers Drs J. Sütő, L. Ackermann, and Z. Bende, and to sen. technicians Mr A. Szóts and Mrs V. Nagy, for their valuable co-operation. This work was carried out with the support of the Telecommunication Machinery Branch of the Csepel Iron and Metal Works Co. (Csepel Vas- és Fémművek Híradástechnikai Gépgyára Budapest).

Summary

During the operation of a spark machining apparatus the dielectric liquid is decomposed. The dependence of the quantity of decomposition products on the parameters of spark machining was determined. Unlike the methods used up to now, here the quantity of the decomposition products is referred to the quantity of the metal expended. The "specific gas evolution" and the "specific carbon formation" thus defined decrease sharply when condenser capacity is increased. From this the distribution of the energy set free in a spark machining process can be deduced. The composition of the gaseous product was determined.

References

1. ROTH, A., KÁLDOS, F., KOVÁCS, J.: Spark Machining (in Hungarian). Műszaki Könyvkiadó, Budapest, 1961.
2. PETCHURO, N. Š., MERKURYEV, A. N., GRODZINSKY, E. J., SOKOLOVA, J. N.: Problems of the Electric Machining of Materials (in Russian). Izd. Akad. Nauk. U.S.S.R., Moscow, 1960.

Prof. Dr. László VAJTA	}	Budapest XI., Budafoki út 8, Hungary
Dr. Pál SIKLÓS		
Lajos NAGY		