

# HEAT TRANSFER IN A SINGLE VERTICAL TUBE CONDENSER-SUBCOOLER\*

## Experimental and theoretical studies

Dr. Ir. M. WEBER

Chaire de Génie Chimique (O.P.U.)  
Université de Liège

Presented by Prof. L. Gy. Nagy  
Received: September 13, 1988

### Abstract

A model for a vertical a condenser-subcooler is described. It is based upon tests performed with:

- a monotubular pyrex condenser equipped for flow visualisation,
- two metallic monotubular condensers-subcoolers (a steel one and a copper one) heavily equipped with measurement devices.

Visualisation tests have shown that there is a sharp discontinuity between the condensation zone and the lower part of the tube. In this region (the flooded zone), the condensate completely fills the tube section. The limit between these two zones is stable in time and space.

The model is built on the following assumptions:

- the liquid film reaching the interface between the condensation and the flooded zones develops a hydrodynamical behaviour compared to a wall jet,
- in the flooded zone, a mixed convection phenomenon occurs.

Longitudinal temperature profiles measured along the tube axis are adequately described by selected correlations.

Generally the new, simple model gives a better agreement than previous correlations, especially in the flooded zone; in some cases, the improvement for design reaches 100%.

### 1. Introduction

The first analysis of film condensation was performed by Nusselt in 1916. Since then there has been substantial analytical work whose aim has been to evaluate the validity of Nusselt's results and to enlarge the field of study related to this problem.

Experimental studies of condensing abound, but relatively few are as complete as the investigation of Goodykoontz and Dorsch [1].

\* Work elaborated in the frame of the scientific cooperation between the T. 21. Budapest and the University of Liège

As far as subcooling is concerned, the actual temperature profile began to be solved by Rohsenow [2] in 1956 for laminar film condensation, so that the mean temperature of the liquid film can now be calculated.

However, the further subcooling of the condensate in the lower flooded region of the tube was studied only by Colburn [3] in 1942.

Condensate subcooling is frequently required to provide the N.P.S.H. for a pump, to cool a product for a surge tank or for storage, to control the reflux temperature in distillation columns in order to avoid off specification products and/or excessive utility consumptions (Figure 1).

Moreover, a vertical condenser-subcooler is also used in the station connecting a building to the district heating system when steam is the energetic carrier.

The purpose of this research [4] is to find out a more accurate design model, especially in the flooded zone. This experimental study is divided into two parts:

- first, visualization tests are run in order to visualize the phenomena and to get a better knowledge of them,
- second, a model is developed and its results are compared with the experimental values.

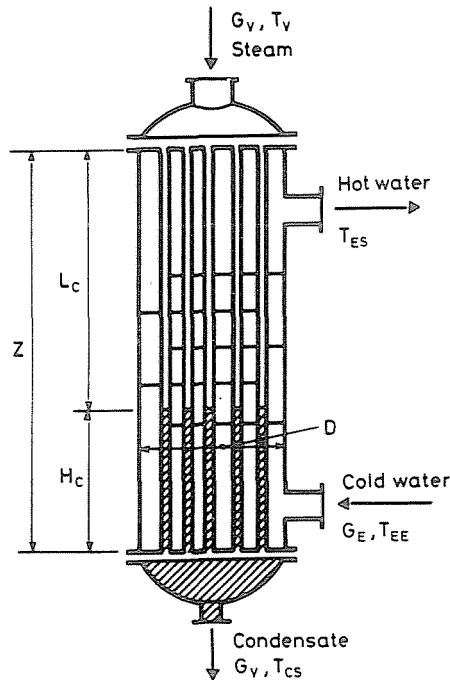

Fig. 1. The vertical condenser-subcooler

## 2. Experimental apparatus

A single test facility has been designed for both research stages. Only the test section and the measurement devices have been changed; first a pyrex condenser has been used, and then a copper one.

### *Description of the test facility*

A schematic drawing of the test facility is shown in Fig. 2.

The single tube test condenser was a shell and tube heat exchanger mounted in a vertical position.

The coolant loop uses demineralized water that is continuously recirculated by means of a volumetric pump.

The coolant flow is measured with a rotameter. The water enters at the bottom of the condenser and flows up in the annulus between the inner and the outer tubes. So the coolant moves countercurrently with the steam. At the highest point of the loop there are an expansion tank and an air trap. Finally a secondary plate heat exchanger of 70 kW is used as the final heatsink. Coming

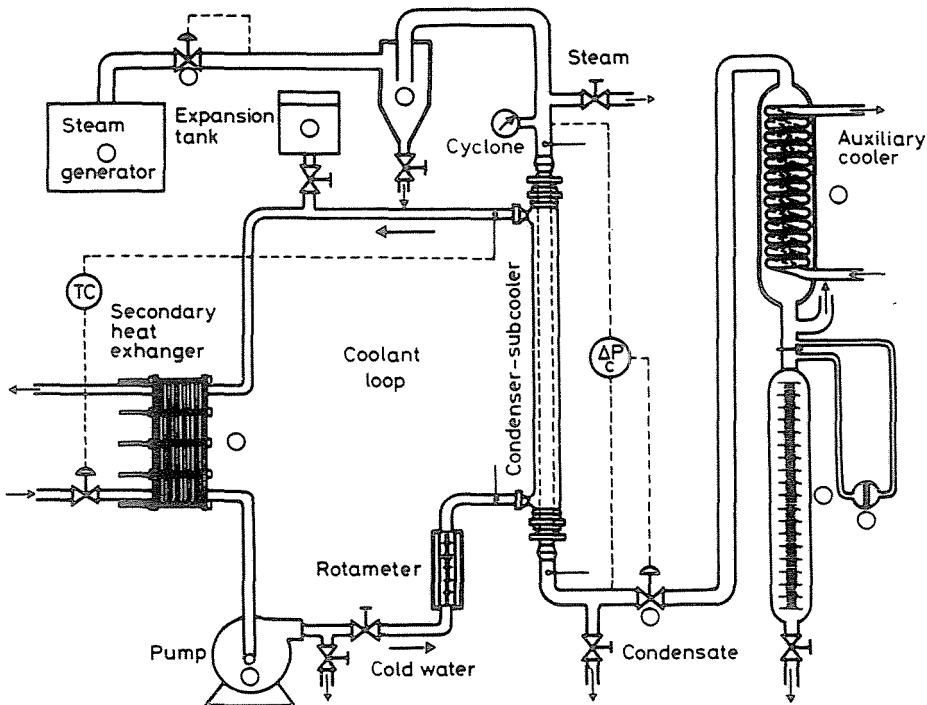

Fig. 2. The test facility

from the steam generator, the vapor at about 1,5 bar is dried in a cyclone just before the condenser. The equipment in the vapor system consists of a cyclone, the condenser, a throttle valve, a secondary cooler and two flow meters.

### *The pyrex heat exchanger*

The inner tube is a thin wall pyrex pipe with a measured outside diameter of 33.6 mm, a measured inside diameter of 30 mm, and a total condensing length of 3.3 m.

The outer jacket is a thick wall pyrex tube. The annular gap between the inner and the outer tubes is 9 mm.

### **3. The visualization tests**

Because of the two pyrex tubes and because of the limpidity of the cooling water, phenomena occurring in the inner tube can be seen clearly. Two separate zones appear in the condenser (Figure 3):

- the upper zone where condensation takes place,
- the lower zone which is flooded by the condensate.

*In the upper zone or condensation zone*, only the condensate can be seen. Although the steam flows down in the core of the axial tube; it is invisible.

The surface of the liquid film is covered with waves at all but extremely low flow rates, as described by Dukler [5]. Nevertheless, a 0.15 m high portion of the film is free of waves at the top of the condenser. The complexity of the flow pattern is apparent from the picture (Photo 1). Even at the lowest flow rates, large wave fronts exist, and are surrounded by fine capillarity waves having the same general contour as the primary wave. As the liquid film flow rate increases (as we go down in the condenser) the number of waves in a given area increases too, the wave spacing is smaller and there are cases where two waves meet.

When all the steam is condensed, a *sharp discontinuity* is visible: the annular two phase flow regime becomes a one phase flow regime. The position of this transition moves neither up nor down when the condenser works in a steady state.

In order to better visualize the fluid motion in *the flooded zone*, the condensate film has been colored with potassium permanganate.

In the condensation zone, the thickness of the film remains small (less than 1 mm), so that the condensate enters the flooded zone as a wall jet (Photo 2). This penetrating jet creates eddies and turbulences that mix the fluid, which is just below the discontinuity. The height of the flooded zone that is perturbed

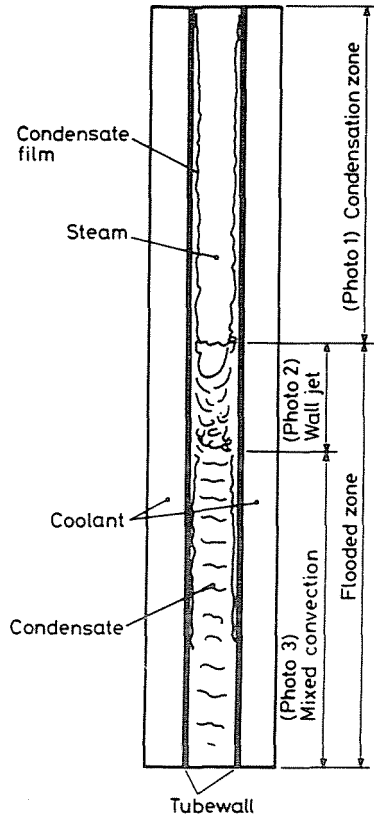

Fig. 3. The various zones in the condenser-subcooler

by the wall jet depends on the condensate flow rate. This height increases with heat flux, but never exceeds 20 cm.

Just below this, a light vertical strip can be seen alongside the tube wall (Photo 3), whereas the core is still well colored. The thickness of this strip decreases as we go down in the tube. In a flow through a channel, the increased velocity near the wall—due to buoyancy—is necessarily compensated for by a decrease in the central region of the channel, and, in the extreme, it may actually produce a reversal in the direction of the flow. Furthermore, the difference of temperature between the tube wall and the condensate decreases along the flooded zone, so that the local velocity and therefore the thickness of the strip decrease.

This establishes the occurrence of combined free and forced convection.

The length of these zones changes from one run to another. It depends on the steam flow rate and on the heat flux.

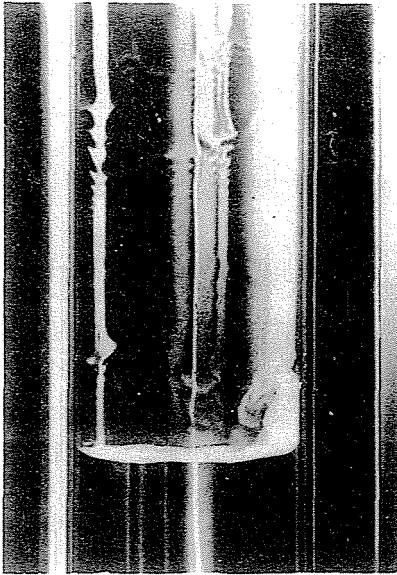

Photo 1. Condensation zone

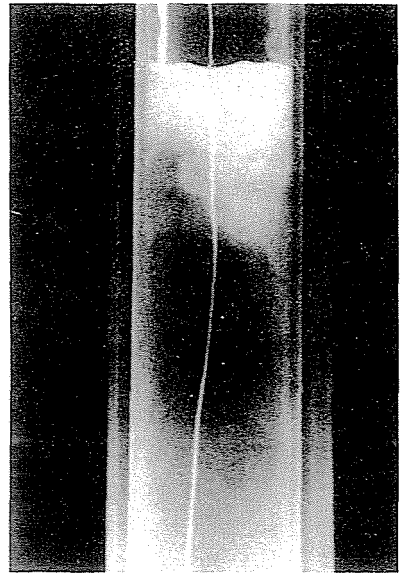

Photo 2. Flooded zone Wall jet

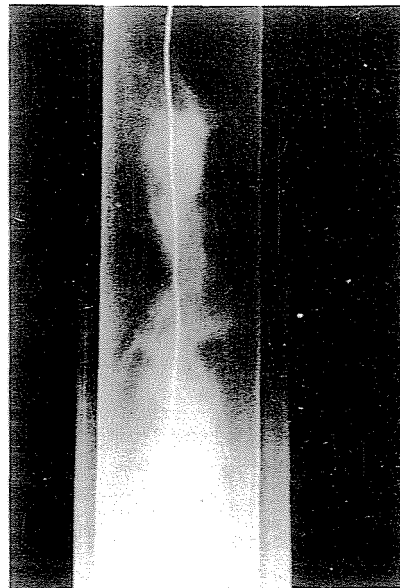

Photo 3. Flooded zone Mixed convection

#### 4. Theoretical aspects

As it has been observed during the visualization tests, the condenser subcooler is divided into two main zones.

For *modelling condensation heat transfer*, the classical model established by Rohsenow [2] has been chosen.

We have used three models among the numerous empirical or semi-empirical models describing condensation inside long tubes:

- Gimbutis' method [6] established for calculating the heat transfer coefficient over the height of a condensation surface under all regimens of condensate film flow with steam at rest,
- Traviss–Rohsenows' model [7], which is an adaptation for condensation in long tubes of Rohsenow's theory,
- recently Butterworth [8] synthesized the results of several works to establish a new model that considers all flow regimes. It should therefore be more accurate.

In the *upper part of the flooded zone*, it can be assumed that heat transfer is governed by the wall jet. The wall jet is usefully thought of as a two-layer shear flow comprising an inner region in which the flow exhibits similarities with that of a conventional boundary layer and an outer layer, where the shear-layer character is more like that of a free shear flow than one bounded by a wall. For the laminar flow regime Glauert [9] searched for a similarity solution of the boundary layer equations in which the form of the velocity distribution across the jet does not vary along its length.

He solved the problem and got the following expression:

$$u = 0.25 * (U * v / x)^{1/2} * f' [0.25 * y * (U / v / x^3)] \quad (1)$$

where  $u$ : local velocity in the jet direction

$x$ : coordinate along wall in the jet direction

$y$ : coordinate normal to wall

$U$ : constant velocity.

The function  $f$  is defined by this relation.

$$0.25 * y * (U / v / x^3)^{1/4} = \ln [(1 + \sqrt{f} + f)^{1/2} / (1 + \sqrt{f})] + \sqrt{3} * \arctg[\sqrt{3} * \sqrt{f} / (1 + \sqrt{f})]. \quad (2)$$

Because of the similarities of the inner region of the wall jet and the conventional boundary layer, it is assumed that heat transfer coefficients ( $\alpha_{fz}$ ) can be calculated using the classical laws. The local Reynolds number used in these relations becomes:

$$Re_x = (U * x / v)^{1/4} * f' [0.125 * d * (U / v / x^3)]. \quad (3)$$

In the case of a turbulent wall jet, Myers [10], using a modified Reynolds analogy, linked the thermodynamic to the hydrodynamic solution. So he predicted the heat transfer to wall jets by the following equation:

$$St_x * Re^{1/5} * 10^2 = 11.8 * (x/b_0)^{-1/16} * (Pr_{air}/Pr)^{0.4} \quad (4)$$

in which  $St_x$ : is the local Stanton number

Re: the slot Reynolds number

$b_0$ : the slot thickness

Pr: the Prandtl number.

In order to extend his results to fluids with Pr different from air, Myers recommended the multiplier factor  $(Pr_{air}/Pr)^{0.4}$ .

We suppose that the border between the upper and the lower parts of the flooded zone is reached when the jet thickness is longer than the tube radius.

Simultaneous free and forced convection phenomena occur in the lower part of the flooded zone. In order to calculate heat transfer coefficients, Churchill's [11] method appears to be satisfactory for both the local and the mean value for many cases. In laminar assisting convection, he proposes the following equation:

$$Nu^3 = Nu_F^3 + Nu_N^3. \quad (5)$$

Whereas, for turbulent convection, he suggests the Martinelli-Boelters' generalized model:

$$Nu = |Nu_F^3 - Nu_N^3|^{1/3}. \quad (6)$$

In this relation  $Nu_F$  et  $Nu_N$  mean, respectively, the Nusselt number for forced convection and for free convection.

The frontier between pure and mixed convection, between laminar and turbulent flow was defined by Metals and Eckert [12]. All our tests are located in the transition zone.

## 5. The quantitative study

The pyrex condenser has been removed from the test facility and replaced by the copper one. The 2.5 m long copper tube condenser (14 mm I.D./21 mm O.D.) was cooled by water circulating in a 5 mm annular space. The shell was a 31 mm I.D. steel tube. 13 pairs of thermocouples measuring the inside wall temperature and the water temperature, were inserted at 200 mm intervals as shown in figure 4. While these latter temperatures could hardly be expected to represent exact average temperature, they were believed to give fair values of the temperature rise from point to point. Moreover, a traveling thermocouple passing along the axis of the tube indicates fluid temperatures in the condensation and in the flooded zones.



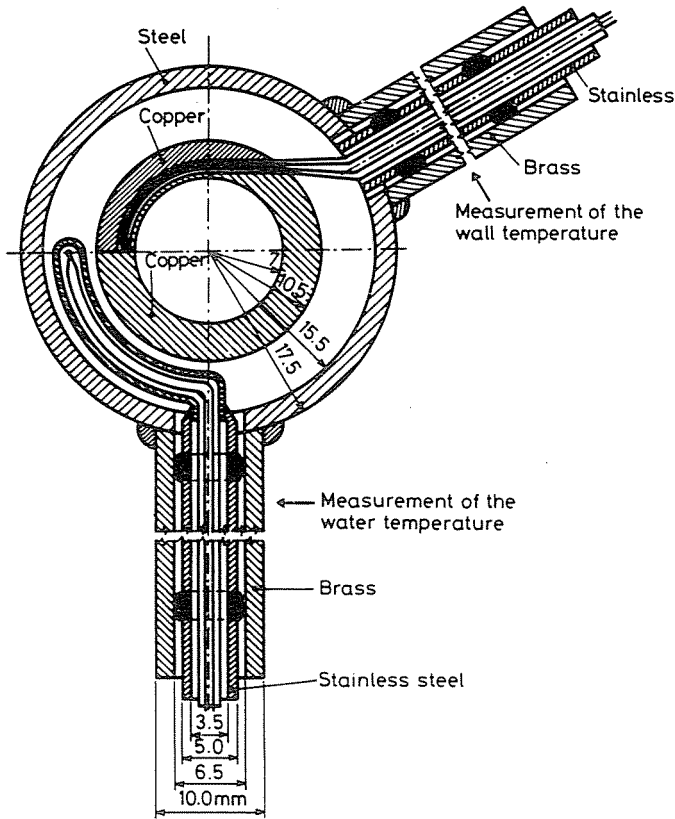

Fig. 4. Thermocouples location

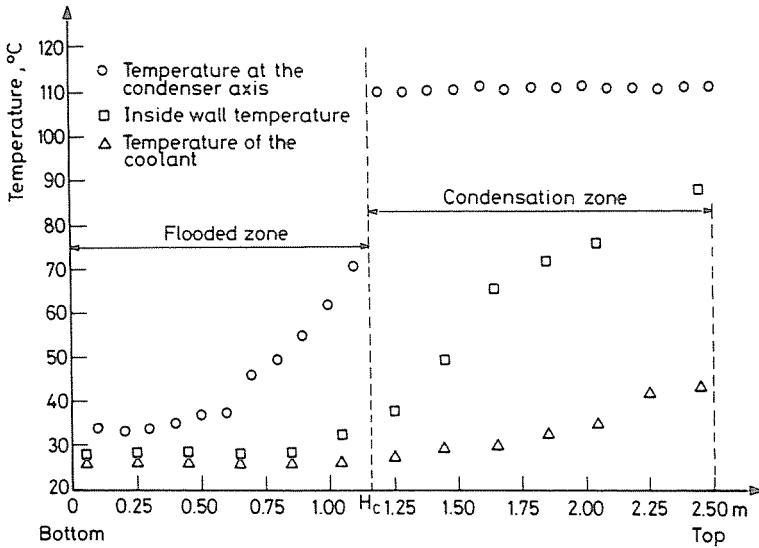

Fig. 5. Temperature profiles along the condenser length

Figure 5 is typical of all the runs. The temperatures indicated by the traveling thermocouple are steady in the condensation zone. In the upper part of the flooded zone (about 10–20 cm) they fall off rapidly, and furthermore, fluctuate widely. After that, in the lower part, they drop off steadily to the exit.

### The condensation zone

#### A. Local heat transfer coefficient

In order to compare our results with the prediction of Rohsenow's model, we have drawn, the theoretical values in full line on a bilogarithmic diagram (Figure 6).

Based on experimental data, three calculated curves are also plotted:

- experimental values for our runs  $n^{\circ}$  306 and 317,
- Rosenow values for the same runs.
- Goodykoontz data.

This diagram shows that the local heat transfer decreases as we go down in the tube. At the bottom of the condensation zone, the Reynolds' number doesn't change any more, while the Nusselt number decreases. This can be explained:

- The vapor velocity as well as the interfacial shear stress decrease rapidly.
- It is possible that a small quantity of uncondensable gas is there and inhibits heat transfer. We have proved that air does not accumulate

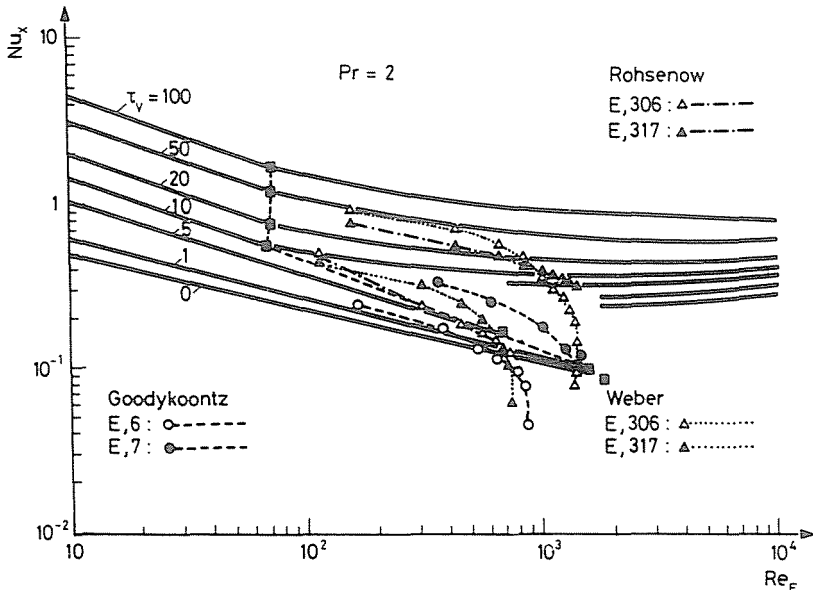

Fig. 6. Local Nusselt number in condensation

because of the balance between the air absorbed by the condensate and the air coming with the steam.

Figure 7 shows that there is a discontinuity in Rohsenow model prediction at the transition between laminar and turbulent flow regimes of the film. Such a discontinuity does not exist with the experimental data. Moreover, the average discrepancy of Rohsenow's model for turbulent film flow, lies in the range of  $\pm 12\%$ .

The comparison of the 317 experimental and theoretical values of the Nusselt number shows an average divergence of 16.7% while the standard deviation is 0.118.

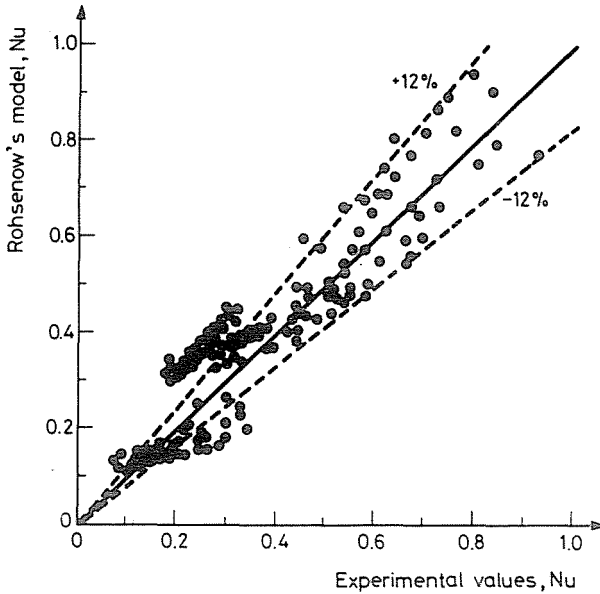

Fig. 7. Local Nusselt number in condensation

### B. Mean heat transfer coefficient

The mean value of the Nusselt number on the whole condensation zone is used to evaluate the accuracy of the semi-empirical methods. Figure 8 is a plot of the mean value of the heat transfer coefficient calculated with these models. It appears that the Traviss and Butterworth models overestimate this coefficient by respectively 87% and 147%; whereas Gimbutis' equation underestimates it by  $-111\%$ . All this discrepancy is to be explained by the particular flow pattern in the vertical condenser subcooler.

With respect to Rohsenow's model, the mean deviation is only 12.2% and the standard deviation is 0.099%.

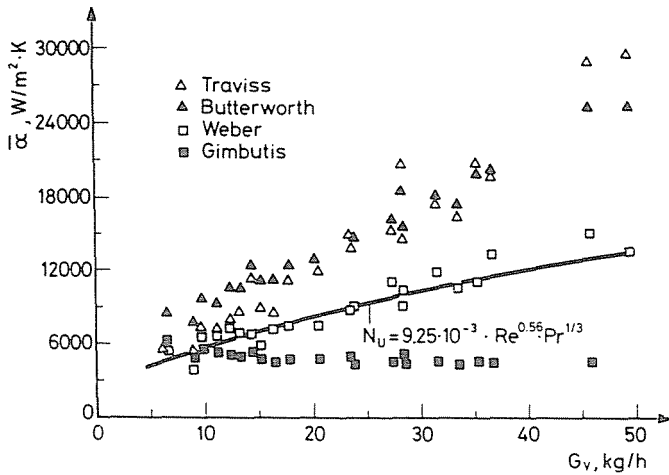

Fig. 8. Mean transfer coefficient in condensation

A new empirical correlation has been found to correlate the mean Nusselt number:

$$Nu = 9.25 \cdot 10^{-3} \cdot Re^{0.56} \cdot Pr^{1/3}. \quad (7)$$

The mean and standard deviations are respectively 10% and 0.037. It is worth noting that this equation has been established for total steam condensation into a 14 mm I.D. vertical tube. The Reynolds and the Prandtl numbers lie respectively between 100 and 1000 and between 1.8 and 2.4.

### *The flooded zone*

#### *A. Local heat transfer coefficient*

Local values of the heat transfer coefficient in the flooded zone have been calculated using the model described earlier. They are plotted versus the experimental data in figure 9. Two main conclusions can be drawn:

- a.) The theoretical model gives several values of the heat transfer coefficient grouped around 1.000 W/m<sup>2</sup>K, when experimental data are scattered between 500 and 5.000 W/m<sup>2</sup>K.

The explanation of this is simple: the model calculates heat transfer coefficients for the lower part (mixed convection) of the flooded zone, while they are still situated in the upper part (jet zone) as the experimental values show.

- b.) In the other case, theoretical values are overestimated and the mean and standard deviations are 55% and 131 W/m<sup>2</sup>K respectively.

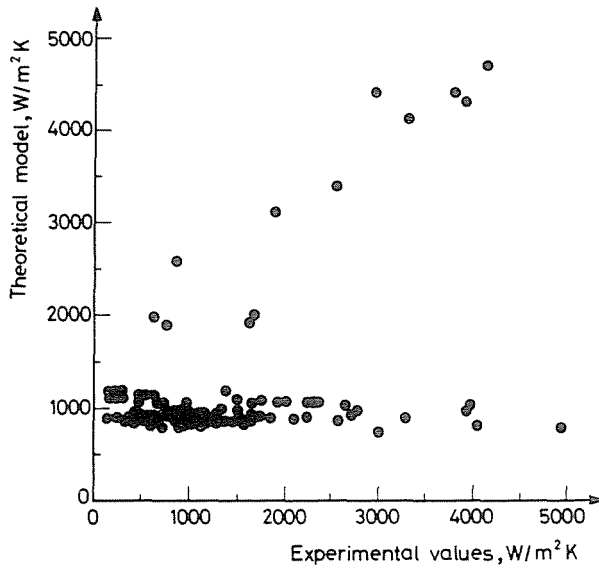

Fig. 9. Local heat transfer coefficient in the flooded zone

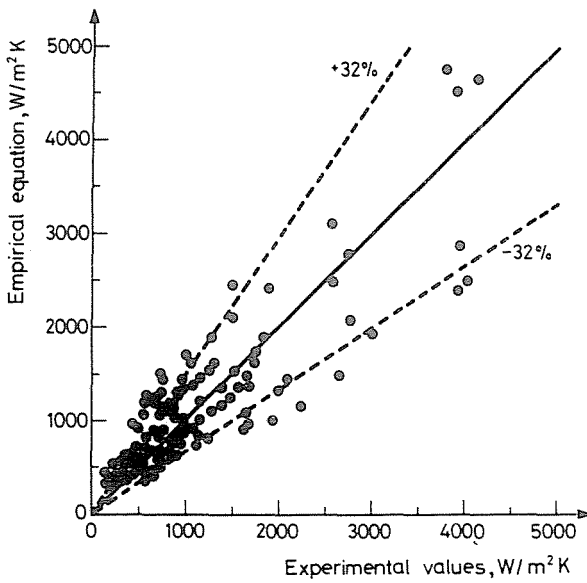

Fig. 10. Local heat transfer coefficient in the flooded zone

### B. A new correlation

Because of this weak accuracy, we have tried to discover an empirical correlation based on the following assumptions:

- the heat transfer is similar to that of a liquid and the wall of a circular tube,
- because of the jet, the boundary layer is not fully developed.

So we find this expression for the local Nusselt number:

$$\text{Nu}_x = 0.00142 * (\text{Re}_x^* \text{Pr}_x)^{1.095} * (1 + 23.51 * d/x). \quad (8)$$

The mean deviation is now 32% and the standard deviation is 224 W/m<sup>2</sup>K (Figure 10). The smaller error on the measured heat transfer coefficient is about 15%, due to weak temperature differences and to weak heat fluxes; so we cannot hope for a better accuracy for the correlation.

Both measurements and calculations have proved that the incondensable gas content always stays under the critical value and does not significantly interfere with heat transfer.

## 6. Steady-state behaviour simulation

A simulation program has been written, which is based on the Rohsenow model, on the wall jet and on the mixed convection phenomena in the flooded zone. Applied to the steady-state behaviour of the vertical condenser-subcooler, it has revealed the effect of three major parameters: the inlet steam flow rate, the cooling water flow rate and the outlet cooling water temperature.

### A. The inlet steam flow rate

Figure 11 shows the parametrical sensitivity of the inlet steam flow rate ( $Gv$ ):

- The condenser power increases linearly with  $Gv$ .
- There is a discontinuity in the flooded zone length ( $Hc$ ) curve and in the curve giving the temperature difference between the outlet of the condensate and the inlet of the cooling water. This discontinuity can be explained: the simulation program uses the Rohsenow model in which such a discontinuity exists at the transition between laminar and turbulent film flow, at low shear stress values.
- When the inlet steam flow rate increases the flooded zone length ( $Hc$ ) decreases and the outlet temperature of the condensate increases too.

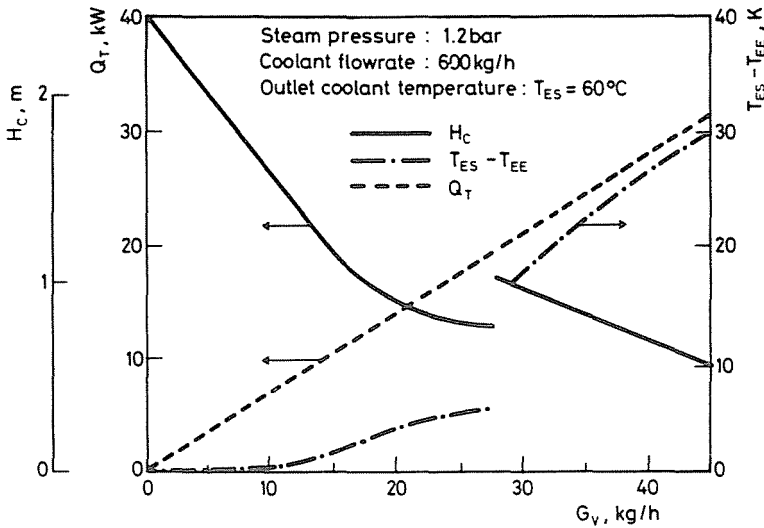

Fig. 11. Effect of the inlet steam flowrate

### B. The outlet temperature of the cooling water

If the outlet temperature of the cooling water ( $T_{es}$ ) changes, Figure 12 shows the evolution of the other parameters.

When increasing  $T_{es}$ , we note that:

- The length of the flooded zone decreases; the difference between the wall temperature and the steam is smaller. Since  $Gv$  remains constant, and since

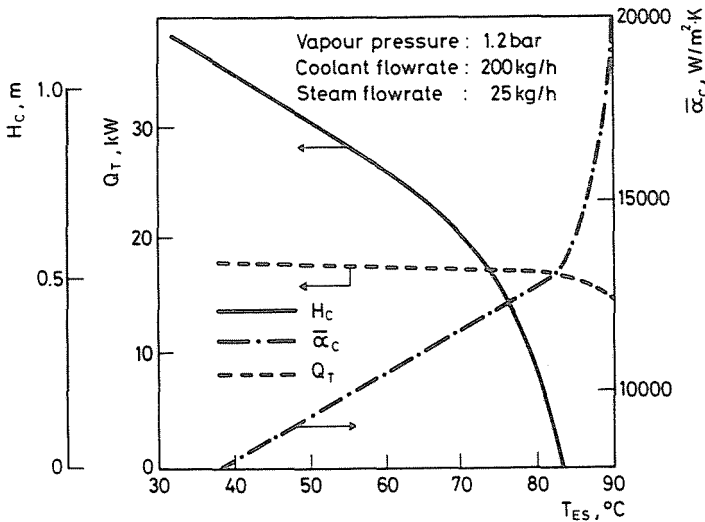

Fig. 12

the steam is completely condensed, the condensation zone must be larger. When  $T_{es}=90^{\circ}\text{C}$ , the condenser tube is not long enough and the condensation is partial.

- The mean transfer coefficient increases because the local values (at the top of the condenser) become larger (the steam velocity is higher when  $T_{es}$  increases).
- The heat flux does not change very much, the slight decrease comes from the higher temperature of the condensate leaving the condenser.

### C. The cooling water flow rate

The cooling water flow rate is less sensible.

For example,  $Hc$  increases from 0.464 m to 0.936 m when the flowrate changes from 300 kg/h to 900 kg/h.

## 7. Conclusions

1. *Visualization tests* have shown that, fundamentally, the condenser subcooler can be divided into two main zones: the condensation zone and the flooded zone. The border between these zones is steady. Heat transfer in the upper part of the flooded zone is governed by a wall jet phenomenon due to the condensate film penetration into a liquid at rest; while combined free and forced convection occur in the lower part of this flooded zone.
2. *The power of a vertical condenser-subcooler* is proportional to the length of the condensation zone. This property is very useful when the heat flux is essentially variable as in district heating applications.
3. *The heat transfer coefficients in the condensation zone* are rather well estimated by Rohsenow's model; nevertheless the mean deviation rises to 16.7%. On the other hand, the semiempirical methods of Gimbutis, of Traviss and of Butterworth are less accurate because of the evolution of the flow pattern during film condensation. At the top of the condenser there is only steam, while at the bottom, steam is completely condensed. Based on experimental data, an empirical correlation has been established to calculate the mean coefficient.
4. *In the flooded zone*, the error on experimental heat transfer coefficient is large because of the small temperature differences and the low heat fluxes. The accuracy of the theoretical model (jet and mixed convection) is then bad (55%), while it is impossible to find a better empirical equation than (8) which has a mean deviation of 32%.
5. In spite of this, *a simulation program* of the steady state behaviour has been written. Compared with the results of the experimental runs, its own results



are excellent: the difference between measured and calculated condensation zone length are lower than 5% and the deviation of the heat fluxes does not reach 2%. Through this program, the effect of major parameters like the steam flow rate, and the cooling water flow rate has been studied.

This study leads to a better knowledge of the vertical condensersubcooler; so the safety coefficient can be reduced in designing such a heat exchanger.

## 8. Nomenclature

$b_0$ : slot thickness	(m)
$d$ : inside tube diameter	(m)
$f$ : function defined in equation (2)	(—)
$Gv$ : inlet steam flow rate	(kg/h)
$Hc$ : length of the flooded zone	(m)
$Nu$ : Nusselt number (mean value)	(—)
$Pr$ : Prandlt number (mean value)	(—)
$Re$ : Reynolds number (mean value)	(—)
$St$ : Stanton number (mean value)	(—)
$T$ : Temperature	(°C)
$u$ : local velocity in the jet direction	(m/s)
$U$ : constant velocity	(m/s)
$x$ : coordinate along the wall direction	(m)
$y$ : coordinate normal to the wall	(m)
$\alpha$ : heat transfer coefficient	(W/m <sup>2</sup> /K)
$\nu$ : cinematic viscosity	(m <sup>2</sup> /s)

### *Subscript*

*air*: relative to air  
*cs*: condensate outlet  
*ee*: cooling water inlet  
*es*: cooling water outlet  
*F*: forced convection  
*fz*: flooded zone  
*N*: natural convection  
*x*: local value

## 9. Literature cited

1. GOODYKOONTZ, J. H., DORSH, G.: "Local Heat Transfer Coefficients for Condensation of Steam in Vertical Downflow within a 5/8 inch-diameter Tube." N.A.S.A. Technical Notes T.N. D-3326 March 1966 pp 1-45.
2. ROHSENOW, W. M., WEBBER, J. H., LING, A. T.: "Effect of Vapor Velocity on Laminar and Turbulent Film Condensation." *Trans. ASME*. Vol. 78, 1956 pp 1637-1643.
3. COLBURN, A. P., MILLAR, L. L., WESTWATER, J. W.: "Condenser Subcooler Performance and Design." *Symposium Series—A.I.Ch.E.* Vol. 13 May 1942 pp 447-468.
4. WEBER, M.: "Etude d'un condenseur sous-refroidisseur—Aspects théoriques et expérimentaux appliqués au dimensionnement industriel." Thèse de doctorat Université de Liège. Février 1988.
5. DUKLER, A. E.: "Fluid Mechanics and Heat Transfer in Vertical Falling—Film System." *Chemical Engineering Progress. Symp. Service*. Vol. 56, 1960 pp 1-10.
6. GIMBUTIS, G. I.: "Local Heat Exchange in the Film Condensation of Stationary Vapor on a Vertical Surface." Translated from *Inshenerno—Fizicheskij Zhurnal*. Vol. 43 n° 3 September 1982 pp 390-397.
7. TRAVISS, D. P., ROHSENOW, W. M., BARON, A. B.: "Forced-Convection Condensation inside Tubes." *A.S.H.R.A.E. Transactions*. Vol. 79 part. 1, 1973 pp 157-165.
8. SCHLUNDER, E. P. et al.: "Heat Exchanger Design Handbook." Vol. 2.—*Fluid Mechanics and Heat Transfer*. Hemisphere Publishing Corporation—Washington 1984.
9. GLAUERT, M. B.: "The Wall Jet." *Journal of Fluid Mechanics*. Vol. 7 part. 6, 1956 pp 625-643.
10. MYERS, J. E., SCHAUER, J. J., EUSTYS, R. H.: "Heat Transfer to Plane Turbulent Wall Jets." *Journal of Heat Transfer—Trans. A.S.M.E.* Aug. 1963 pp 209-214.
11. CHURCHILL, S. W.: "A Comprehensive Correlating Equation for Buoyancy Induced Flow in Channels." *Letters in Heat and Mass Transfer*. Vol. 4, 1977 pp 193-199.
12. METAIS, R., ECKERT, E. R. G.: "Criteria for Mixed and Free Convection Regimes." *Journal of Heat Transfer—Trans. A.S.M.E.* May 1964 pp 295-296.

Dr. Ir. M. WEBER Université de Liège